

Lösungen zu Runde 5: Vermischtes

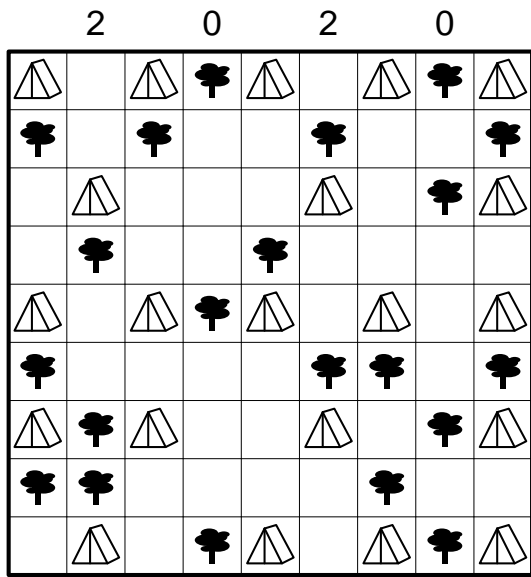

5.1 Zeltlager

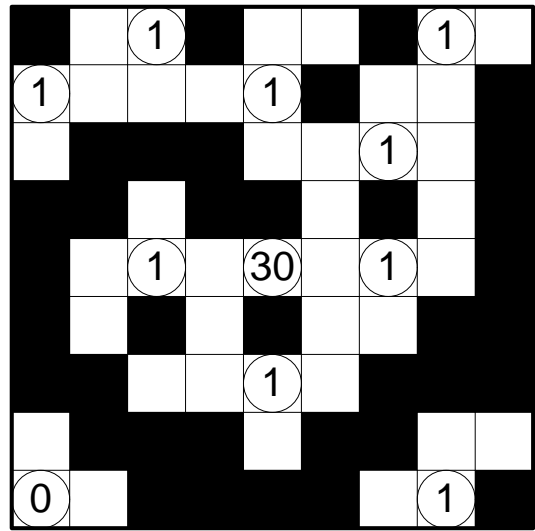

5.2 Kurotto

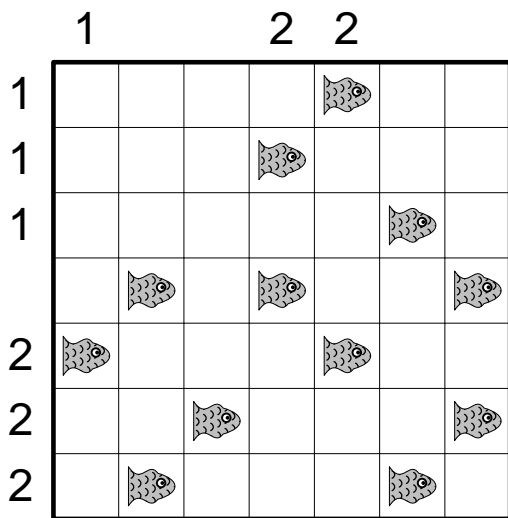

5.3 Fischpaare

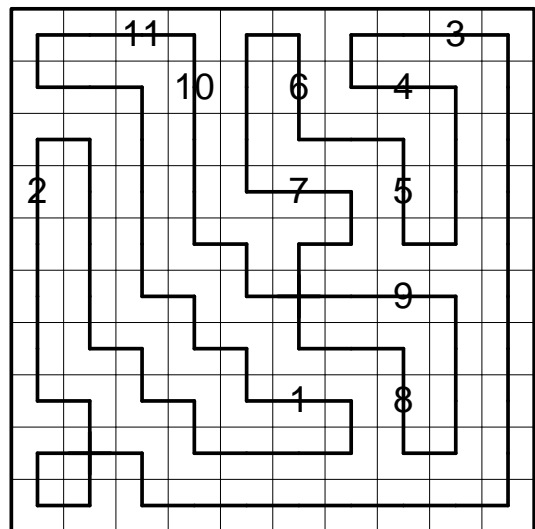

5.4 Bahnhöfe

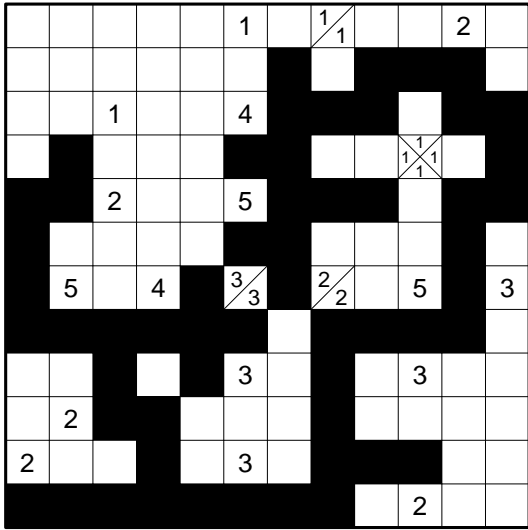

5.5 Tapa

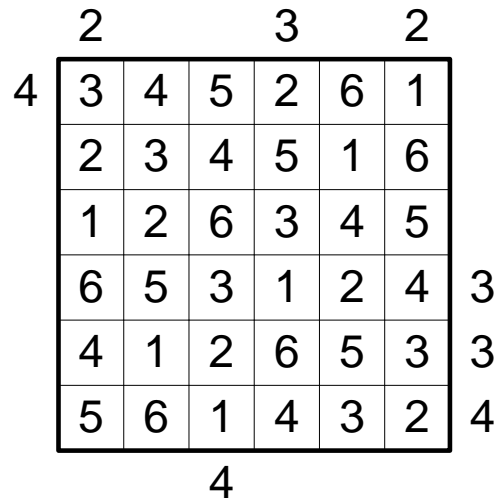

5.6 Hochhäuser

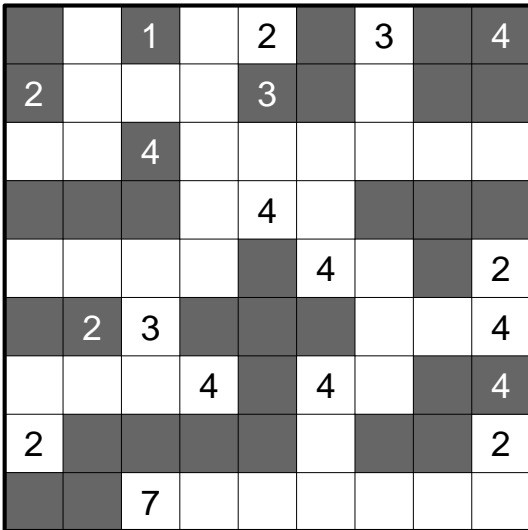

5.7 Twilight-Höhle

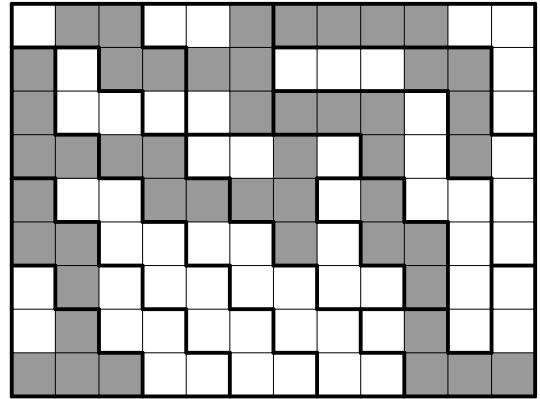

5.8 LITS

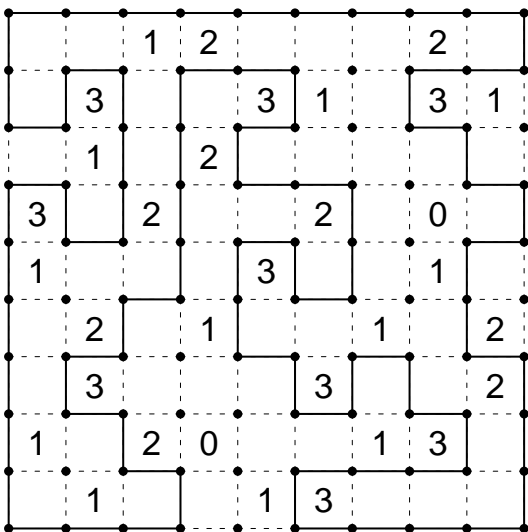

5.9 Rundweg

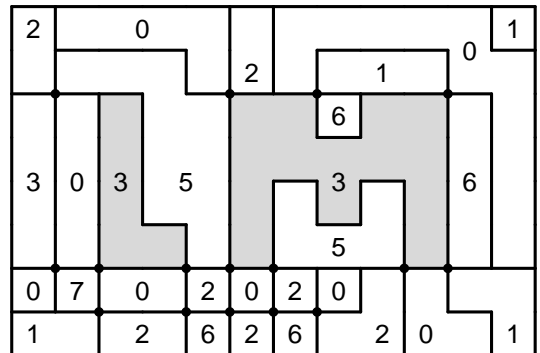

5.10 Terra X

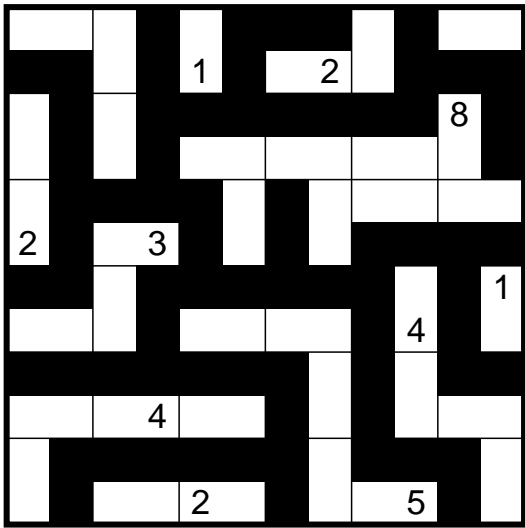

5.11 Minikoralle

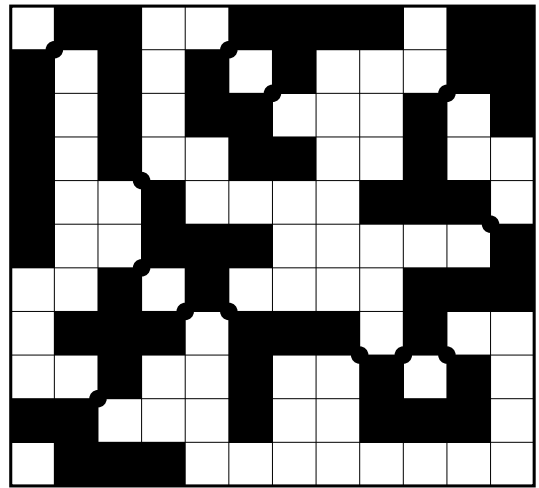

5.12 Touching Pentominos

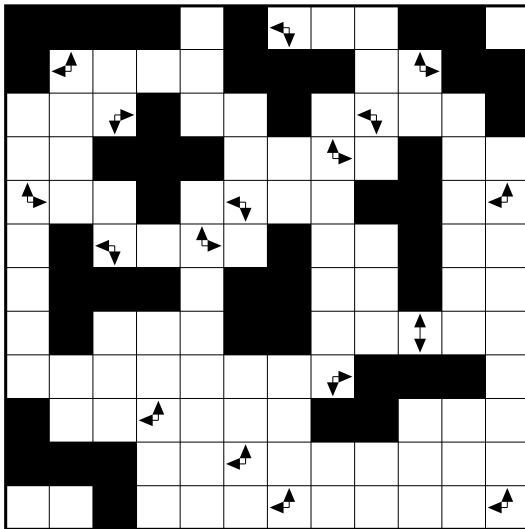

5.13 Pentopia

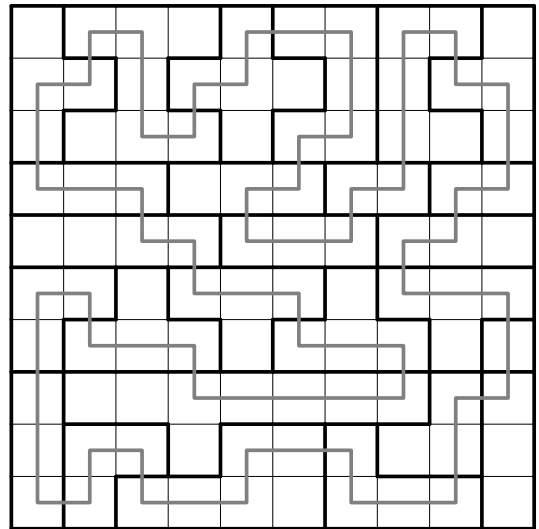

5.14 Countryroad

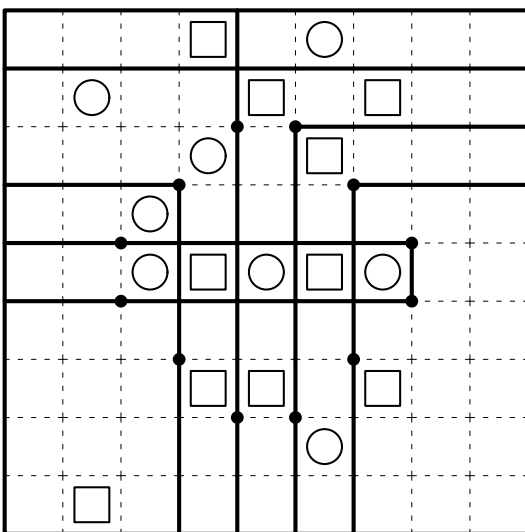

5.15 Yagit

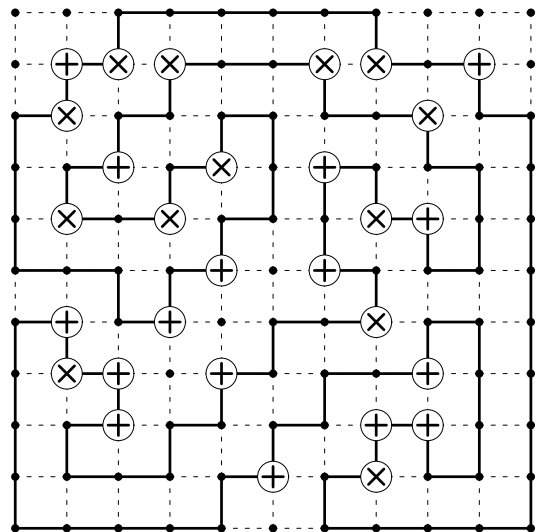

5.16 Elbschifferrundweg

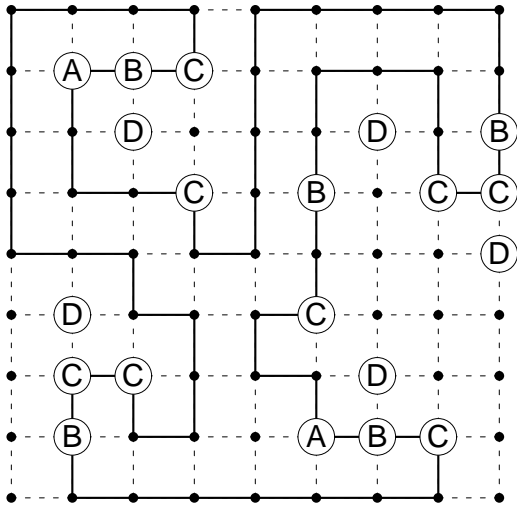

5.17 Elbschiffer Krypto

1	2	3	1	1	2	1	3
6	5	4	2	2	1	4	2
7	1	2	1	3	2	1	4
1	3	1	2	1	3	2	1
2	2	2	1	2	2	3	3
3	5	3	1	3	1	1	2
1	4	1	2	1	3	2	1
2	3	2	3	1	2	1	2

5.18 Permakultur Hakyuu-Worms

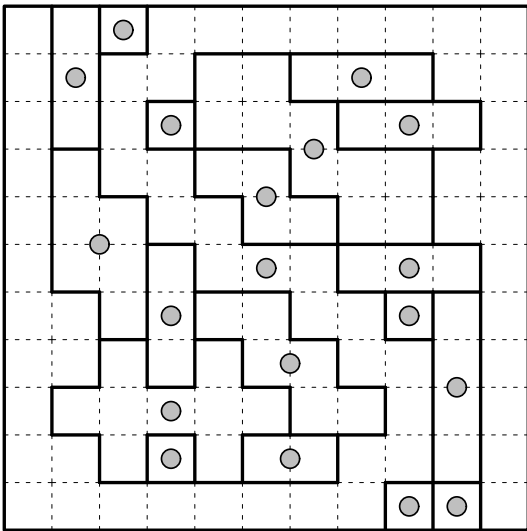

5.19 Galaxien

		3	2					4	
		2	3		4				
			2					2	
				2					
		3	2		2				

5.20 Heyawake

			14	12	12		5	7	17	4
		10		9	1	18		6	9	3
10		2	3	5	6	3	1	2		
5	2	3	6	8	6	2	6	5	1	
17	7	9	1	10	7	2		1		
	4	10	4	3	1	8	7	7	15	6
7		4	2		1	4	5	2	3	
5	3	2	9	12	5	7		5	1	4
11	1	3	5	2	7	1		4	2	
8		1	4	3	19	3	9	7		

5.21 Kakuro mit Lücken

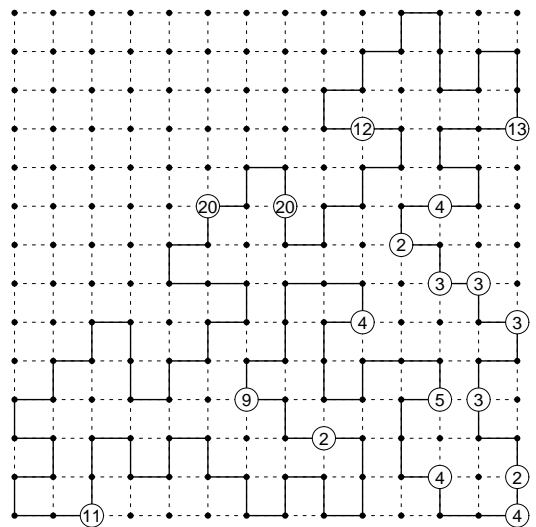

5.22 Kongruenzrundweg

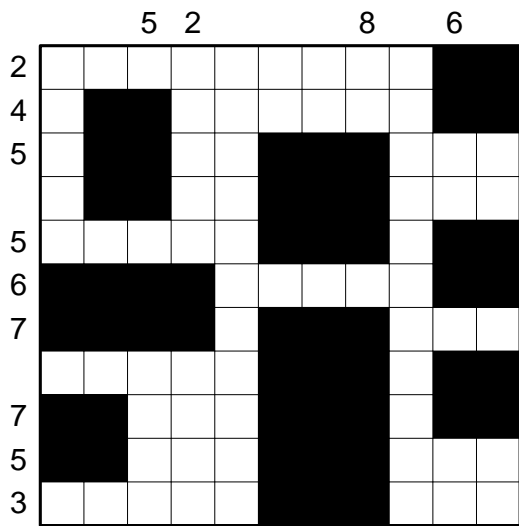

5.23 Radar

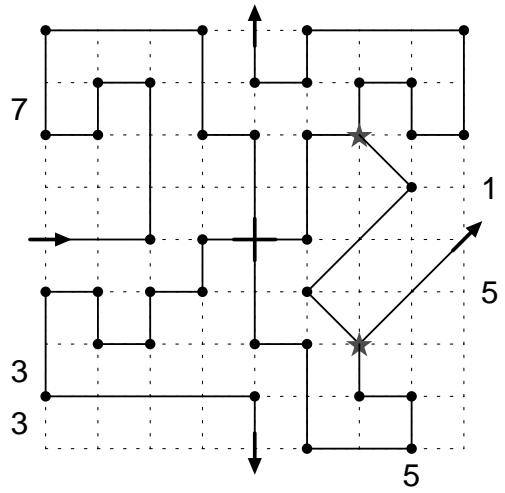

5.24 Teilchenzoo

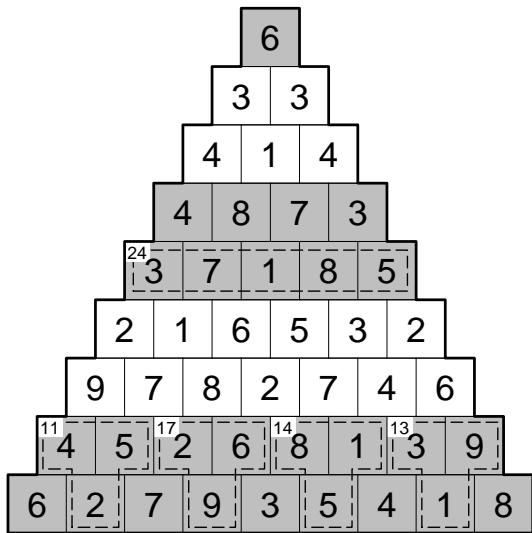

5.25 Killer-Pyramide