

1.1 Point a star

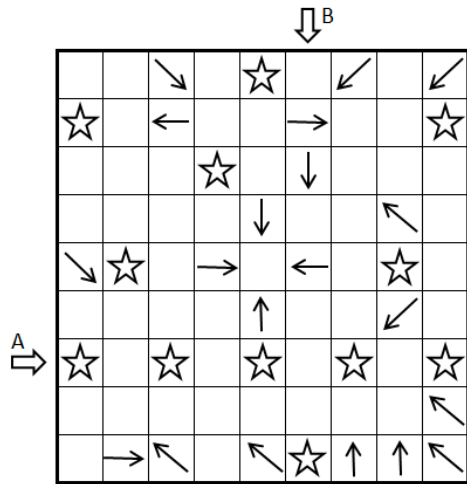

1.2 Scrabble

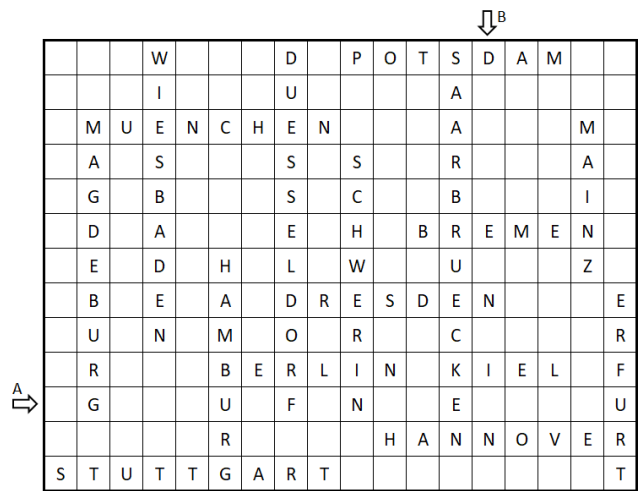

1.3 Zwischenknick

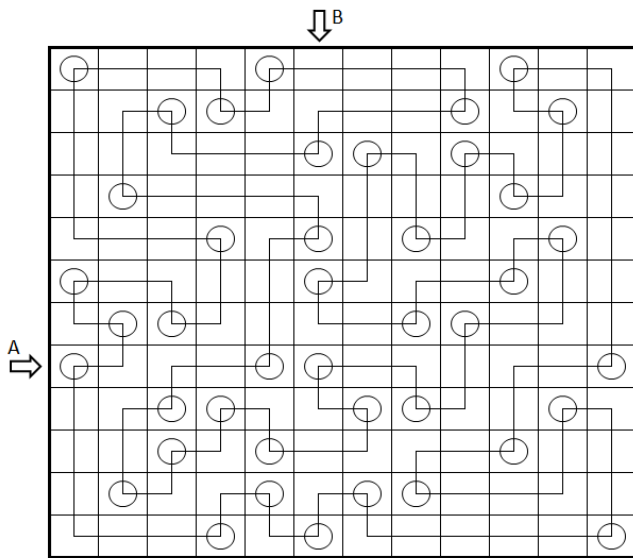

1.4 BACA

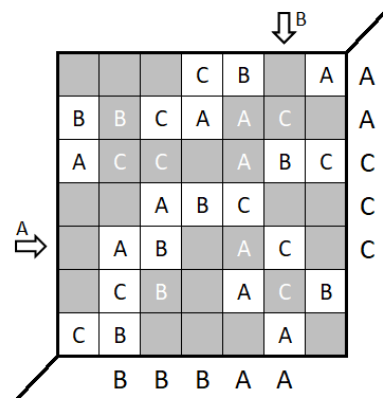

1.5 Yin Yang

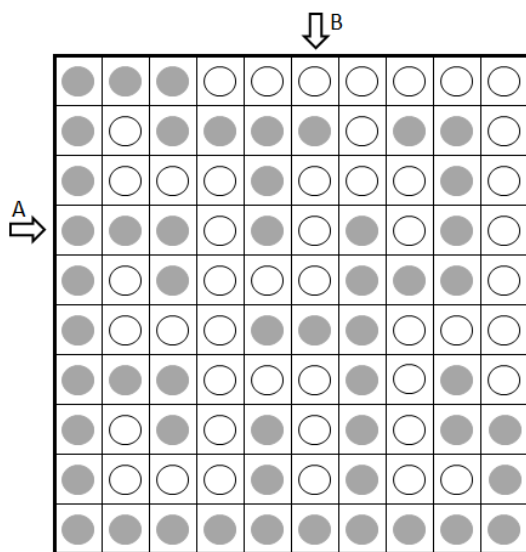

1.6 Chatroom

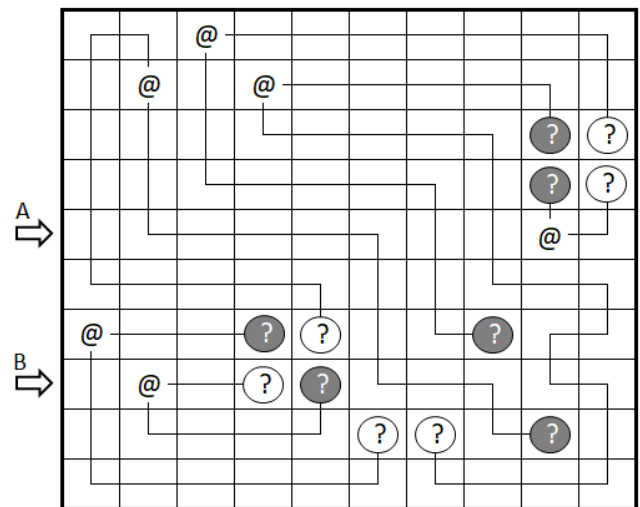

B2

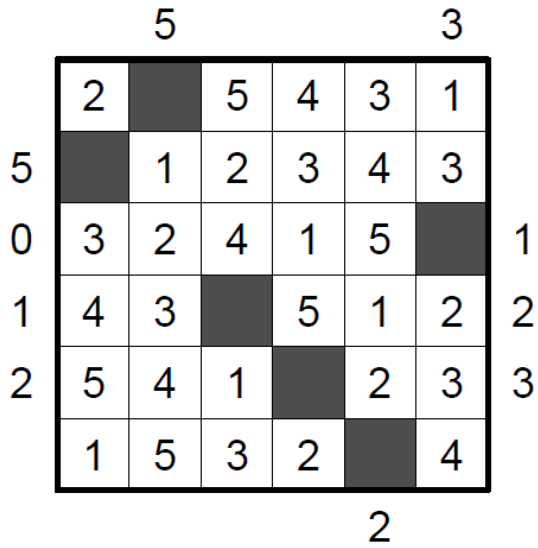

B3

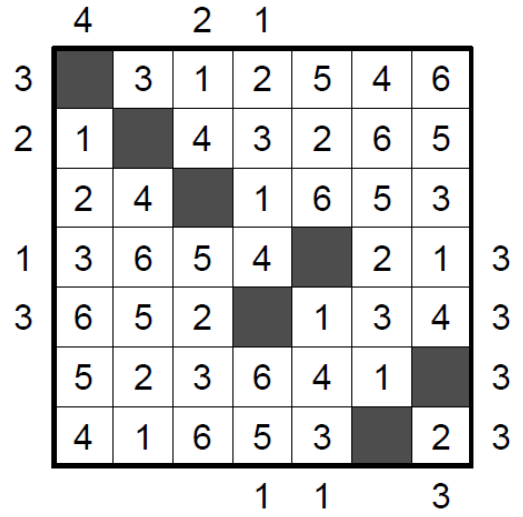

B4

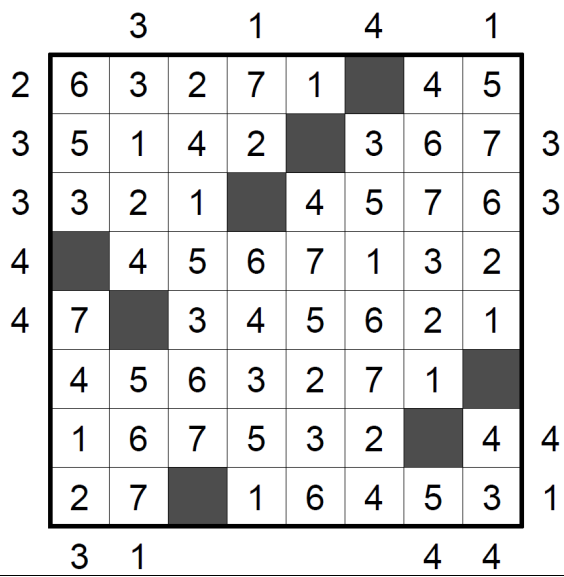

C1

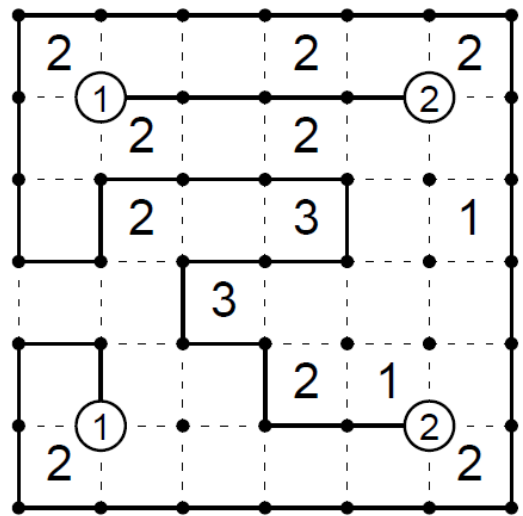

C2

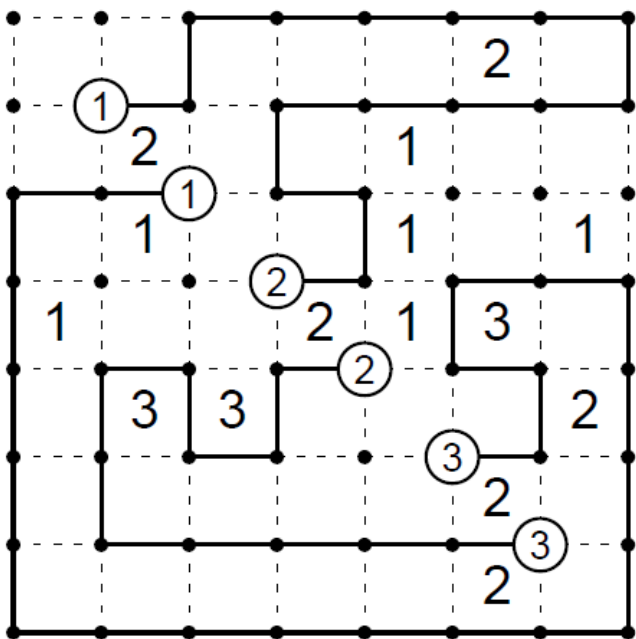

C3

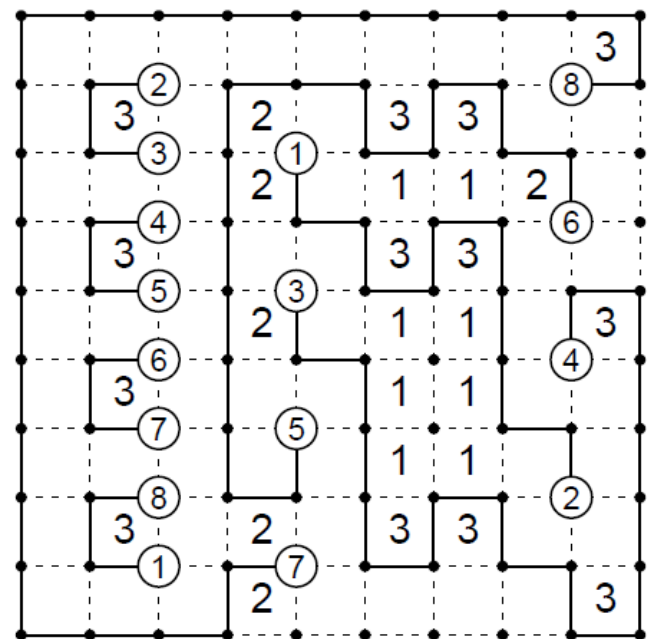

C4

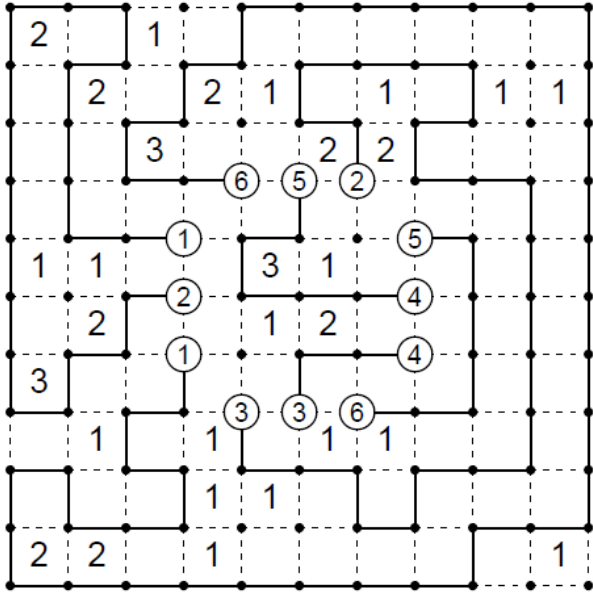

D1

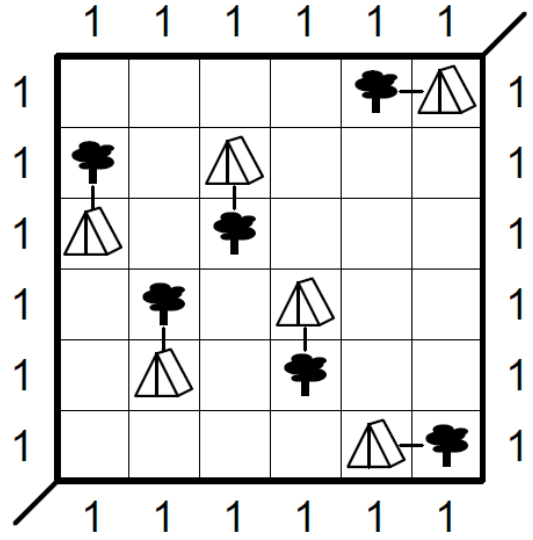

D2

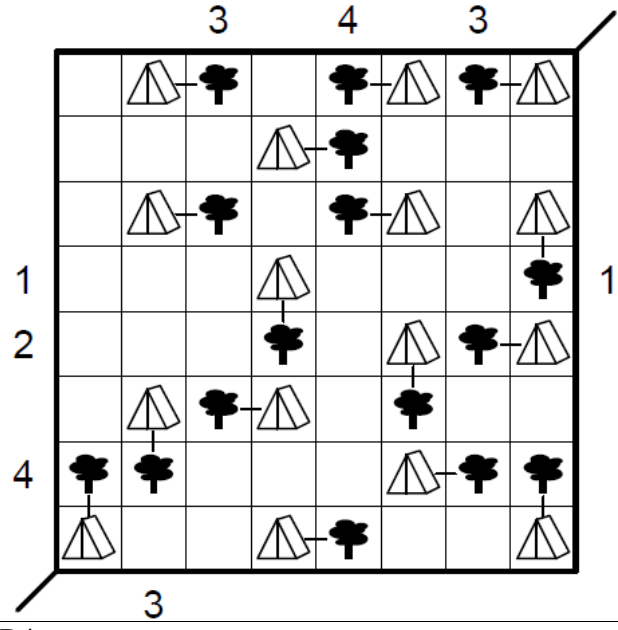

D3

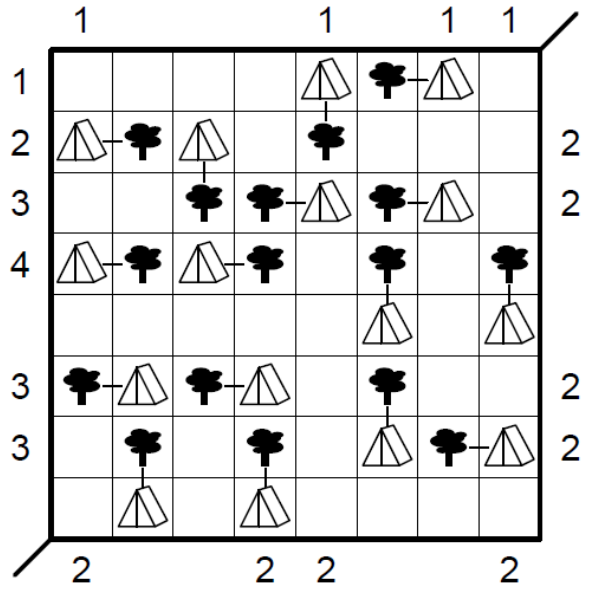

D4

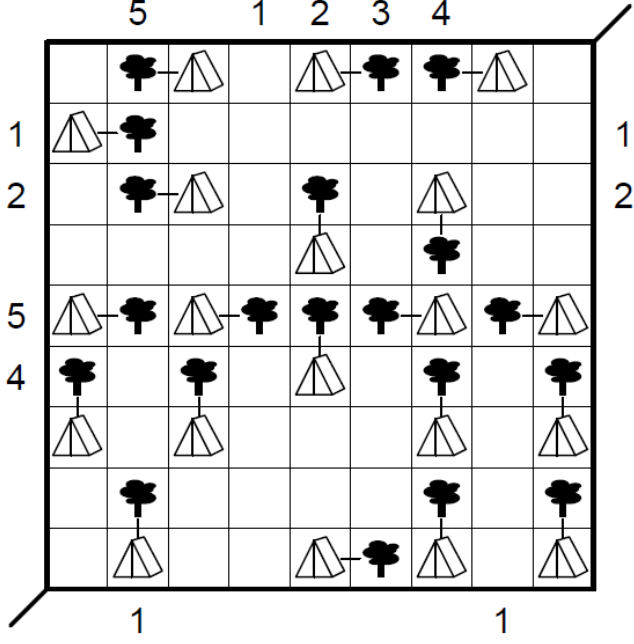

3.1 Inseln

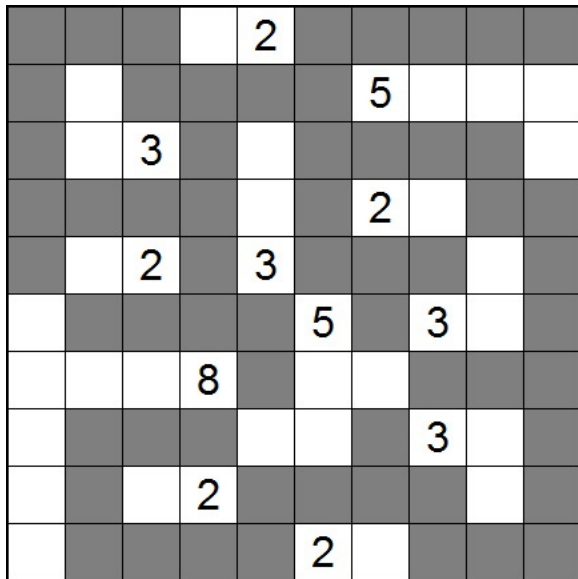

3.2 Angler

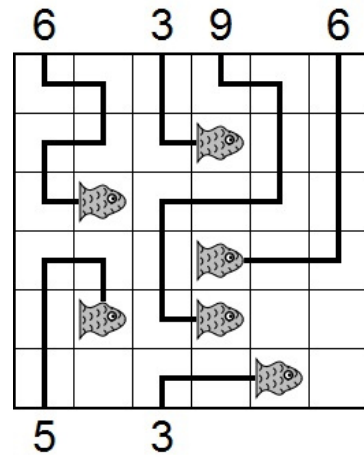

3.3 Angler auf Inseln

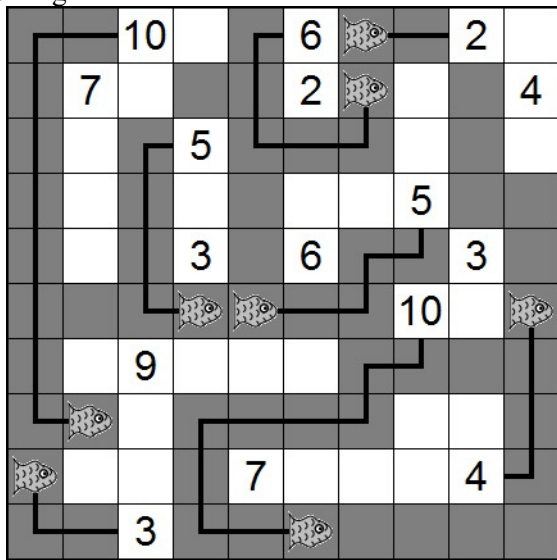

3.4 Doppelstern

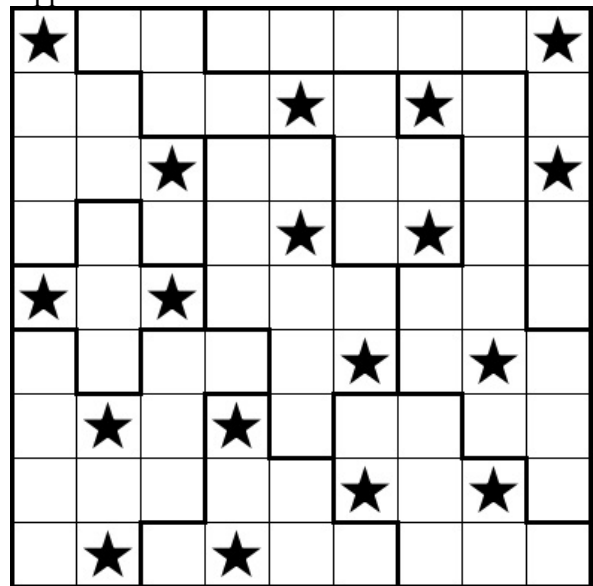

3.5 Summen

| | | | | | | |
|-----|---|---|----|----|----|----|
| | 8 | 4 | 76 | 30 | 16 | 35 |
| 126 | 2 | 3 | | 1 | 2 | 1 |
| 216 | | 2 | 1 | 3 | | 3 |
| | 3 | 1 | | 2 | | 1 |
| | | 2 | 1 | 3 | | |
| 9 | 2 | 3 | | | 1 | 3 |
| | | | | 1 | 3 | 2 |
| | | | 3 | | | 1 |
| 185 | 1 | 3 | 2 | 2 | 1 | 3 |
| 6 | | 1 | | 3 | 2 | |

3.6 Doppelstern Summen

| | | | | | | |
|------|----|---|-----|---|---|-----|
| | 93 | 4 | 124 | | 4 | 521 |
| | 1 | 0 | 3 | 2 | 0 | 3 |
| 42 | 3 | 2 | 1 | 0 | | 0 |
| | 0 | 0 | | | | 2 |
| | 2 | | | 1 | 0 | 0 |
| | 0 | | | 0 | | 3 |
| 4 | 1 | | 1 | 2 | 0 | 0 |
| | 3 | 0 | 0 | | 3 | 1 |
| 35 | 2 | | 3 | 1 | 0 | 2 |
| | 0 | | 0 | | 2 | |
| 16 | | 1 | 0 | 2 | 0 | 3 |
| | 3 | 2 | | 0 | | 2 |
| 5027 | 1 | 3 | 0 | 1 | 3 | 2 |

4.9 Kreuzsummen (Hartmut Seeber)

↓

| | | | | | | | | | |
|-------------------|----|-----------------|-----------------|----|-----------------|-----------------|-----------------|----|----|
| waager. senkr. | 12 | 16 | | 35 | 16 | | 15 | 15 | 11 |
| 11 | 4 | 7 | 10 | 7 | 3 | $\frac{13}{30}$ | 8 | 2 | 3 |
| 9 | 6 | 3 | $\frac{32}{20}$ | 5 | 8 | 4 | 7 | 6 | 2 |
| 31 | 2 | 6 | 8 | 3 | 5 | 7 | $\frac{13}{17}$ | 7 | 6 |
| | 10 | $\frac{11}{13}$ | 5 | 6 | 11 | 3 | 8 | 12 | 15 |
| 16 | 3 | 4 | 7 | 2 | $\frac{16}{12}$ | 2 | 6 | 3 | 5 |
| 9 | 2 | 7 | 28 | 8 | 5 | 6 | 3 | 4 | 2 |
| 7 | 5 | 2 | 19 | 4 | 7 | 8 | 13 | 5 | 8 |

→

Runde 5 – Silke Berendes

| | |
|------------------------|---------------------------|
| 5.1 Schlange | 5.2 Persistence of memory |
| 5.3 Hochhäuser | 5.4 Numbered rooms |
| 5.5 Bahnhöfe | 5.6 Suraromu |
| 5.7 Pillen | 5.8 Hidden Fences |
| 5.9 Partiti | 5.10 No same sums |
| 5.11 Fillomino | 5.12 Kariertes Fillomino |
| 5.13 Yin Yang | 5.14 LITS+ |
| 5.15 Kakuro mit Lücken | 5.16 Blackout Domino |

Runde 6 – Jonas Gleim

6.1 Hochhäuser

6
↓

| | | | | | | |
|-----|---|---|---|---|---|---|
| 4 ▶ | 2 | 4 | 1 | 5 | 6 | 3 |
| 5 ▶ | 1 | 3 | 2 | 4 | 5 | 6 |
| | 5 | 2 | 3 | 6 | 1 | 4 |
| | 6 | 5 | 4 | 1 | 3 | 2 |
| | 4 | 6 | 5 | 3 | 2 | 1 |
| | 3 | 1 | 6 | 2 | 4 | 5 |

◀ 5
◀ 5

6 5
↓ ↓

| | | | | | | |
|-----|---|---|---|---|---|---|
| | 5 | 6 | 3 | 1 | 4 | 2 |
| | 4 | 5 | 6 | 2 | 1 | 3 |
| 4 ▶ | 1 | 2 | 5 | 3 | 6 | 4 |
| | 6 | 1 | 2 | 4 | 3 | 5 |
| | 3 | 4 | 1 | 5 | 2 | 6 |
| 4 ▶ | 2 | 3 | 4 | 6 | 5 | 1 |

↑
4

6.2 Tetropia

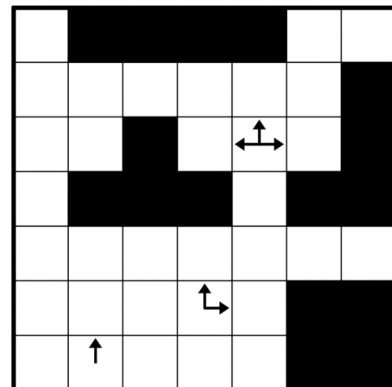
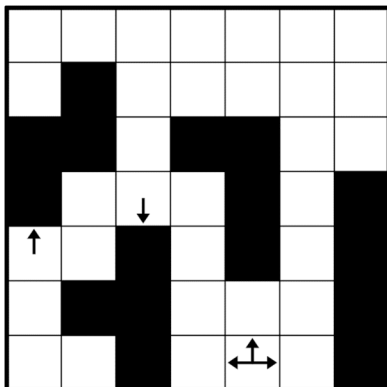

6.3 Masyu
fehlt

6.4 Tapa

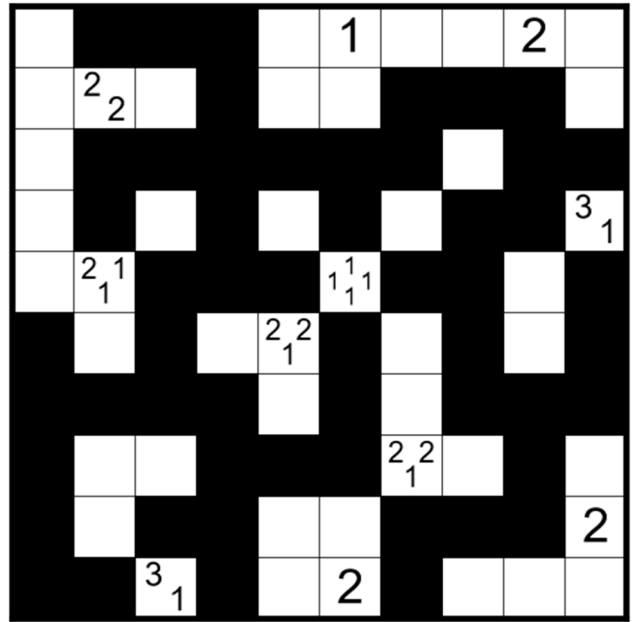
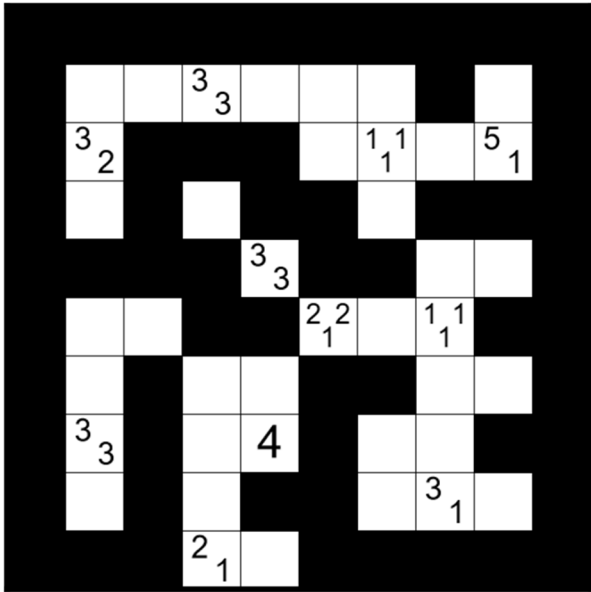

6.5 Shakashaka

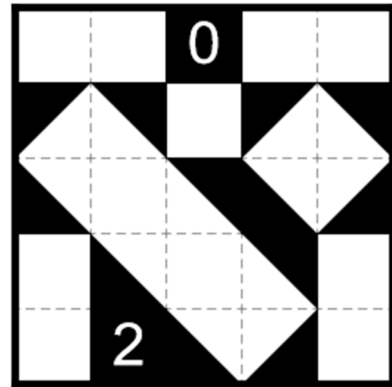
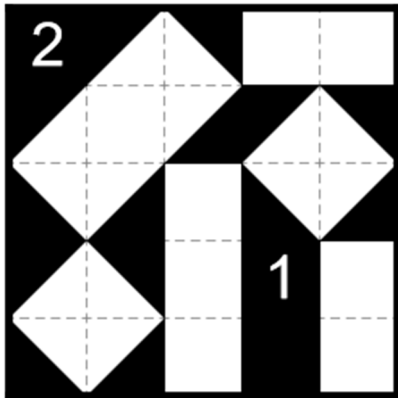

6.6 Pentomino-Zerlegung

6.7 Rundweg (Unequal lengths)

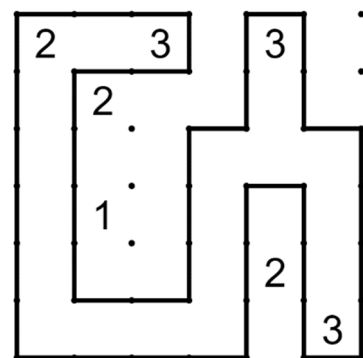
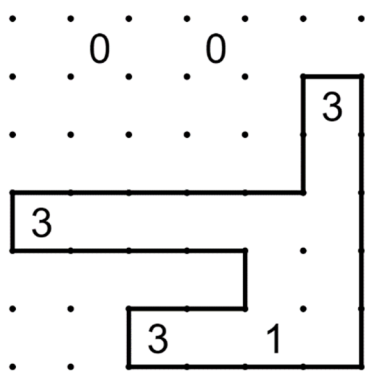

7.7 Round Trip

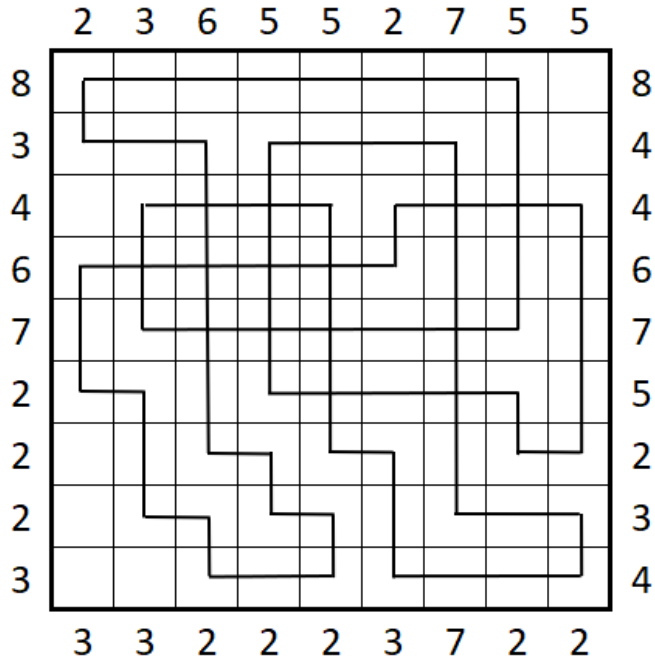

7.8 Summenbild Rundweg

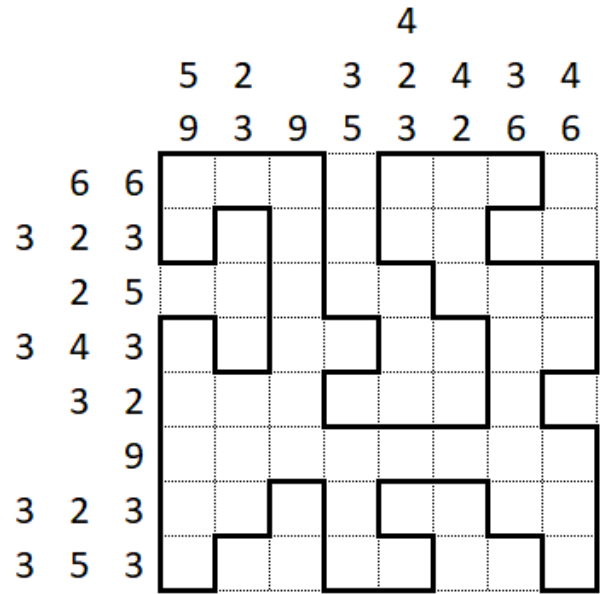

7.9 Summenbild Rundweg

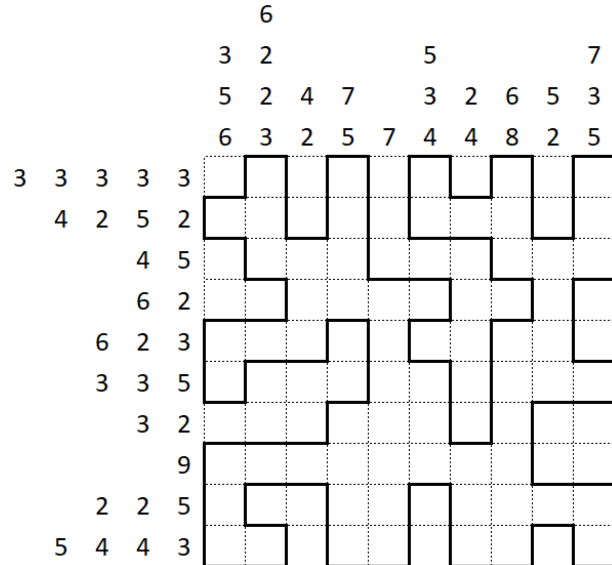

Runde 8 – Philipp Weiß

8.1

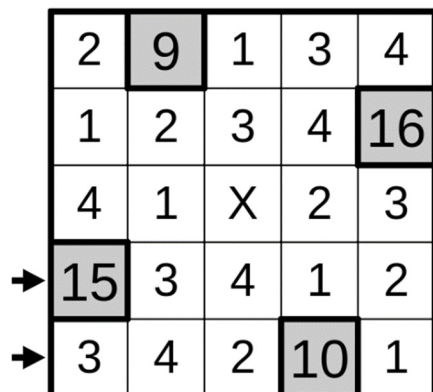

8.2

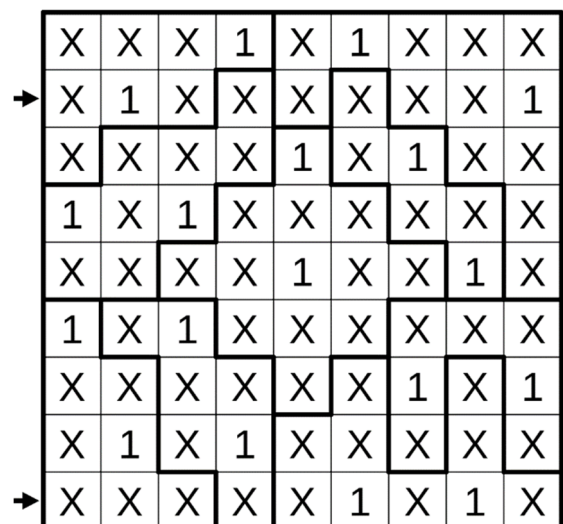

8.3

| | | | | | | | | | | |
|---|---|---|---|-------|-------|---------|---------|---------|-------|---------|
| | | | 1 | | 1 | | 0 | | | |
| | | | 3 | | 2 | | 2 | | | |
| | | | 4 | | 4 | | 2 | | | |
| | | | 4 | 2 | 2_4 | 2 | 0_2^0 | 0 | 0_2 | |
| → | 0 | 2 | 3 | 1 | 1 | 1 | X | 0 | X | 2 |
| | | | | 2_3 | X | 1_4^2 | 1 | 0_1^0 | X | 0_2 |
| | 0 | 1 | 5 | 1 | 2 | 2 | X | 1 | X | 0 |
| | | | | 0_5 | 2 | 4_6 | 2 | 1_5^2 | 2 | 0_2^1 |
| → | 0 | 1 | 4 | 0 | X | 1 | 1 | 2 | X | 1 |
| | | | | 0_1 | 1 | 1_3 | 1 | 2_4 | 2 | 1_2 |

8.4

| | | | | | | | |
|---|----|--------|-------|----|-------|-------|----|
| | X | X | X | 21 | 21 | 21 | |
| | 21 | 10_6 | X | X | 6_3 | 8_5 | X |
| → | 21 | 32 | 32 | 32 | 32 | 32 | 21 |
| | 21 | X | X | X | X | X | X |
| | 21 | 5_3 | 6_3 | 32 | 32 | 7_4 | X |
| → | 21 | X | 21 | 21 | 21 | 21 | X |

8.5

| | | | | | | | | | | | |
|---|---|---|---|---|---|---|---|---|---|---|---|
| | | | 2 | | 2 | | 2 | | | | |
| 3 | 1 | X | X | 3 | X | X | 3 | 4 | X | X | |
| | X | X | X | 2 | X | 1 | X | X | X | X | 2 |
| | X | 4 | X | X | X | 3 | 2 | X | 1 | X | 4 |
| → | 2 | 1 | 2 | 1 | 2 | X | X | X | X | X | 1 |
| → | 2 | X | X | X | X | 1 | X | 2 | X | 1 | 2 |
| | 2 | X | 2 | 1 | X | X | X | 1 | X | X | |
| | | 2 | | 3 | | 2 | 3 | | 1 | | |

8.6

| | | | | | | | | | |
|-------|-------|--|-------|-------|--------|-------|-------|-------|----|
| | | | 12 | | 30 | | 20 | | |
| | | | 51 | | 33 | | 43 | | |
| | | | 1 | 10 | 0 | 21 | 11 | 20 | 21 |
| → | | | 20 | 21 | 10_5 | 11 | 10 | 0 | 1 |
| 22 41 | | | 10 | 20 | 21 | 1 | 0 | 7_3 | 11 |
| | | | 11 | 0 | 1 | 9_5 | 20 | 10 | 21 |
| 12 51 | | | 0 | 6_5 | 11 | 20 | 21 | 1 | 10 |
| | | | 21 | 1 | 20 | 10 | 8_5 | 11 | 0 |
| → | 11 52 | | 3_3 | 11 | 10 | 0 | 1 | 21 | 20 |

8.7

| | | | | | | | | |
|---|---|---|---|---|---|---|---|---|
| | 2 | 3 | 1 | 3 | 1 | 5 | 1 | 4 |
| → | 1 | 4 | 2 | 5 | 4 | 3 | 2 | 5 |
| | 3 | 5 | 3 | 1 | 2 | 5 | 4 | 3 |
| → | 4 | 1 | 4 | 5 | 4 | 3 | 1 | 2 |
| | 5 | 2 | 3 | 2 | 1 | 2 | 4 | 5 |

8.8

| | | | | | | | | | |
|---|-------|---|-------|-------|---|---------|---|-------|-------|
| | 2 | 2 | 1_2 | X | 1 | X | 2 | 2_2 | X |
| | 2_4 | X | 1 | X | 1 | 2_2^2 | X | 1 | 1 |
| → | 2 | X | 1 | 1_3 | X | 2 | X | 1 | 3 |
| | 2 | X | 1 | 2_4 | X | 2 | X | X | 1_2 |
| → | 2_3 | 1 | X | 2 | 2 | 2_3^2 | 1 | X | 2 |
| | 1 | 1 | 2_4 | 2 | X | 1 | 1 | 2_4 | 2 |

8.9

| | | | | | | | | |
|-----|-----------------|-----------------|----------------|-----------------|-----------------|-----------------|-----------------|---|
| X | 2 | 6 | 1 | 8 | 4 | X | X | X |
| X | ²² 4 | ⁴⁰ 4 | 5 | ⁴⁴ 5 | 2 | ⁴ 2 | ¹¹ X | 1 |
| → X | 3 | 7 | X | 9 | 7 | 9 | X | 3 |
| 4 | ³¹ 5 | 2 | X | ²³ X | ²⁵ X | ⁹ X | ³¹ 6 | 6 |
| → 2 | 7 | 3 | 5 | 8 | 6 | 9 | 5 | 8 |
| X | ²² 1 | ³⁷ 4 | 1 | X | ⁶ X | ²² X | X | X |
| X | X | 9 | 7 | X | 3 | X | 4 | 2 |
| X | ²³ 6 | ⁴³ 9 | ³ 9 | ⁶ 6 | ⁶ 6 | ⁷ 6 | ¹¹ 5 | 5 |
| X | X | 8 | 3 | 1 | 8 | X | 7 | X |

8.10

| | | | | | | | | | | | | | | |
|-----|---|---|---|---|----|---|---|---|---|---|---|---|---|---|
| | | | | 1 | | | | 1 | | | | | | |
| | | | | 2 | 1 | 2 | 1 | 1 | | | | | | |
| | | | | 4 | 2 | 4 | 2 | 2 | | | | | | |
| | | | | 8 | 7 | 7 | 8 | 4 | | | | | | |
| 2 | 5 | 5 | | 1 | 3 | 1 | X | 2 | X | 1 | 3 | 1 | | |
| 2 | 4 | 5 | | 3 | 1 | X | 2 | X | 1 | 3 | 1 | X | | |
| → 1 | 2 | 3 | 4 | 1 | X | 2 | X | 3 | X | 1 | 3 | X | | |
| | 2 | 3 | 3 | 4 | 3 | X | X | 3 | 1 | X | 3 | X | 2 | |
| | | | | 2 | 9 | X | 1 | 3 | 1 | 3 | 1 | X | 2 | X |
| | 1 | 1 | 1 | 2 | 1 | X | 1 | X | X | X | 2 | X | 1 | |
| → 2 | 3 | 3 | 4 | 3 | X | 3 | X | X | 2 | X | 1 | 3 | | |
| | | | | 2 | 4 | X | 2 | X | 1 | 3 | X | X | X | |
| | | | | 2 | 13 | 2 | X | 1 | 3 | 1 | 3 | 1 | 3 | 1 |

8.11

| | | | | | | | | | |
|-----|---|---|---|---|---|---|---|---|---|
| | | 3 | | 4 | | 2 | | | |
| 3 | 2 | 2 | 4 | 1 | 3 | 3 | 5 | | |
| | 2 | 5 | 1 | 3 | 1 | 1 | 1 | 3 | |
| → | 5 | 1 | 3 | 1 | 4 | 1 | 3 | | |
| | 4 | 1 | 3 | 1 | 4 | 1 | 5 | 1 | |
| | | 3 | 1 | 5 | 2 | 5 | 2 | 4 | 2 |
| → 2 | 1 | 4 | 2 | 2 | 2 | 2 | 2 | | |
| | 4 | 2 | 2 | 5 | 2 | 4 | 2 | 3 | |
| | | 3 | | 2 | | 3 | | | |

9.1 Yin Yang

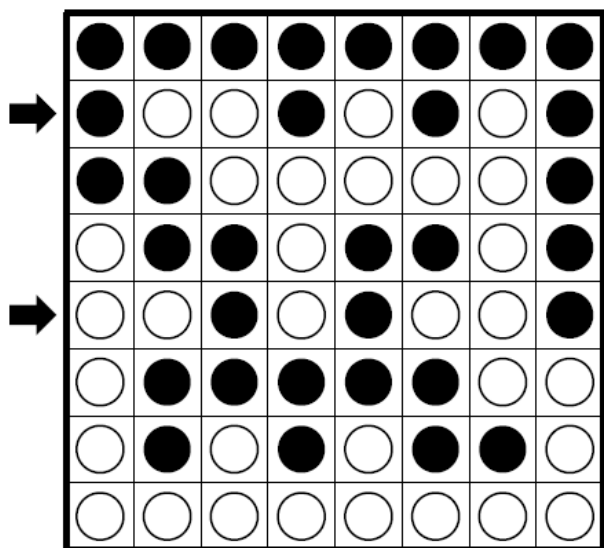

9.2 Masyu

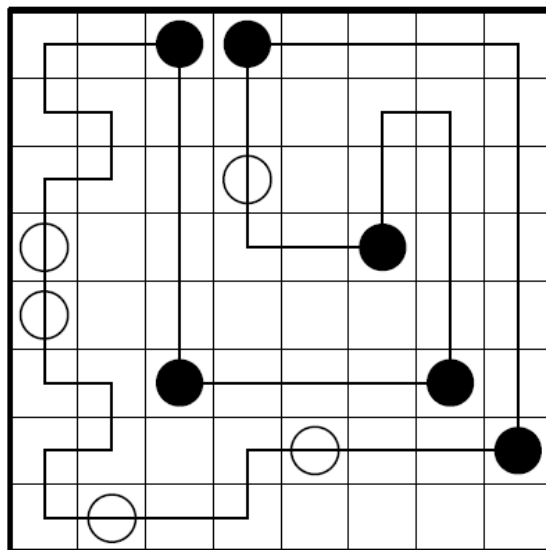

9.3 Buchstaben-Zahlensalat

| | | | | | | |
|---|---|---|---|---|---|---|
| | A | A | A | A | | |
| C | C | A | 3 | 2 | 1 | B |
| B | B | 2 | A | 1 | 3 | C |
| C | 1 | C | B | A | 2 | 3 |
| C | 3 | 1 | C | B | A | 2 |
| A | B | 2 | 3 | C | 1 | 1 |
| C | 2 | 3 | 1 | C | B | A |
| | 3 | | 3 | 2 | | |

9.4 ABC-Box

| | | | | | | |
|---|---|---|---|---|---|---|
| | | | | | | ? |
| | ? | ? | | ? | 2 | |
| | 2 | C | ? | 3 | ? | ? |
| | ? | ? | ? | A | ? | ? |
| 2 | B | ? | A | A | B | A |
| → | | | B | C | B | A |
| | ? | C | ? | B | B | B |
| | C | 3 | ? | C | B | B |
| → | | ? | ? | C | B | B |
| | ? | ? | ? | C | B | A |
| | | | | A | A | B |
| | | | | B | B | |

9.5 Myopia

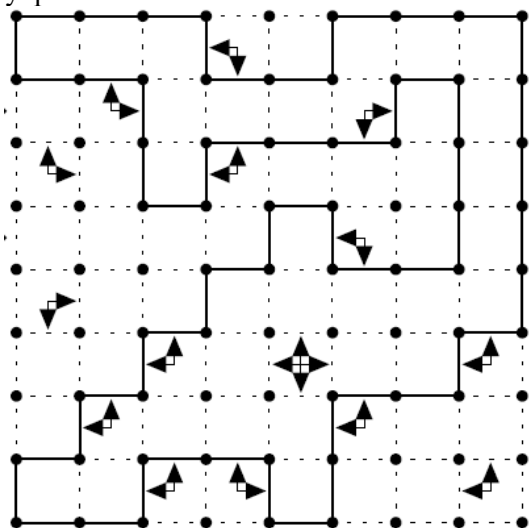

9.6 Pentopia

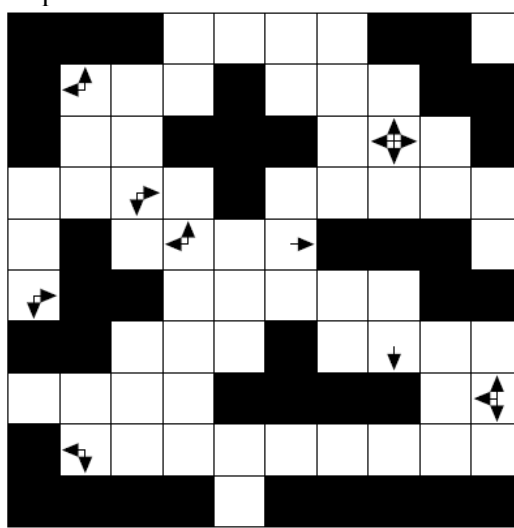

9.7 Rundweg

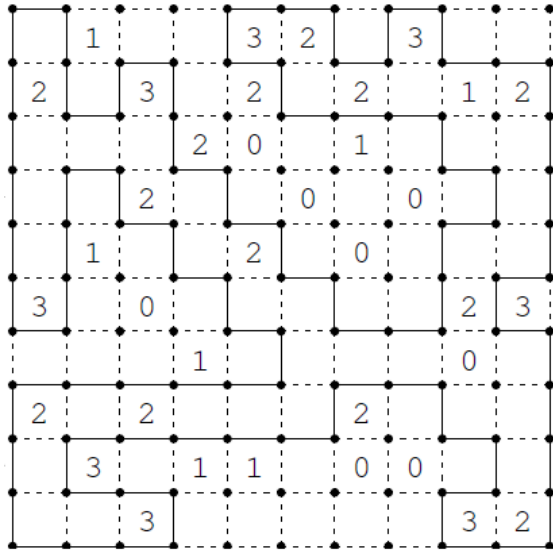

9.8 Haus-Baum-Tier

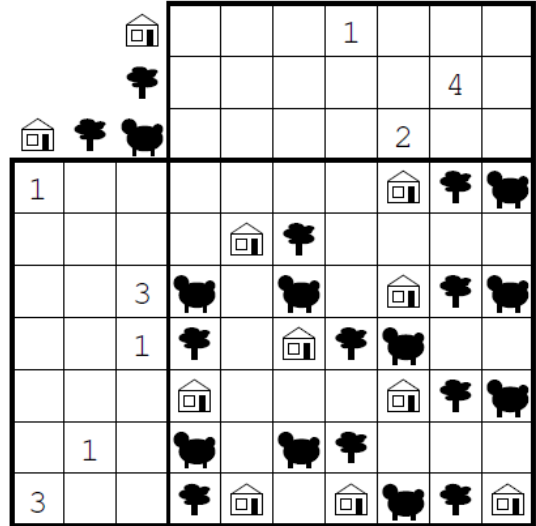

9.9 ABCtje

| | | | | | | | |
|----|---|----|----|----|----|----|---|
| B | D | E | G | H | I | L | M |
| 10 | 1 | 14 | 13 | 2 | 4 | 12 | 8 |
| N | O | P | R | S | T | U | Z |
| 6 | 9 | 7 | 15 | 16 | 11 | 3 | 5 |

9.10 Summon

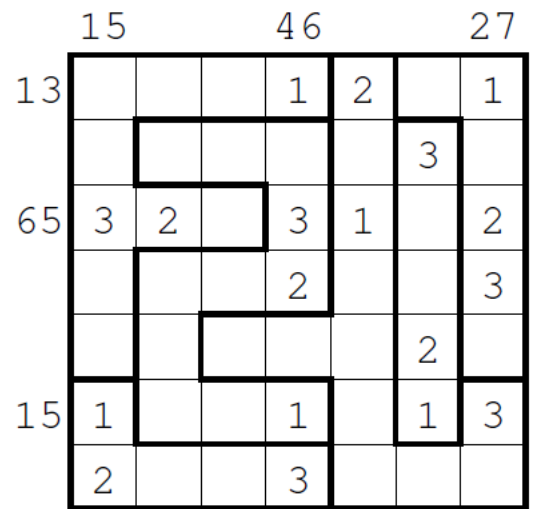

9.11 Japanische Summen

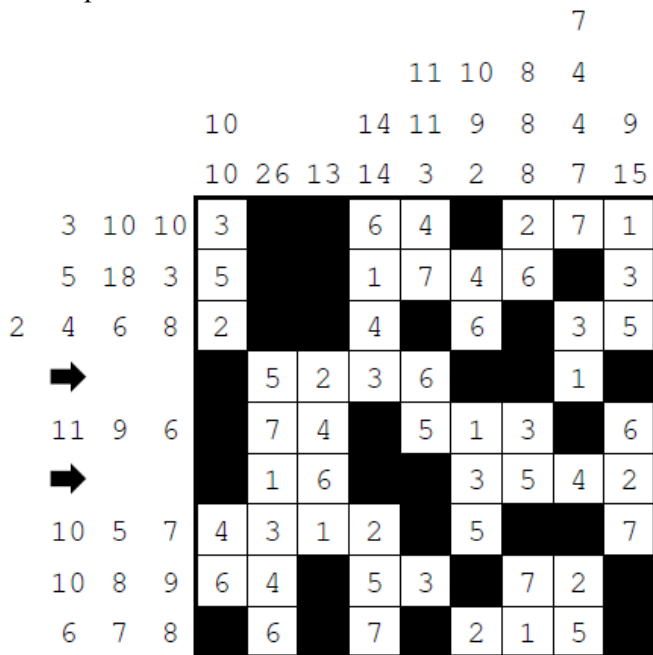

9.12 Araf

