

Rundweg

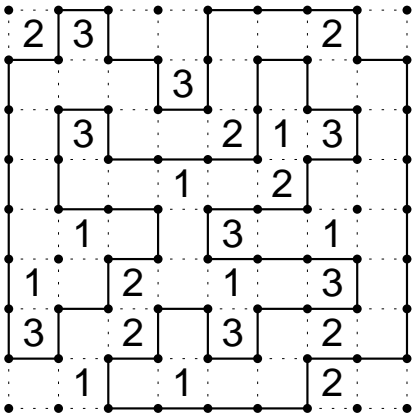

Rundwegvarianten: Lösungen

Doppelter Rundweg

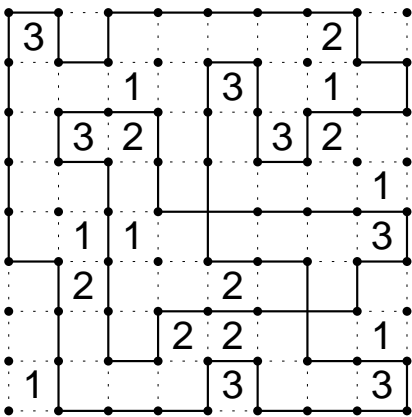

Krypto-Rundweg

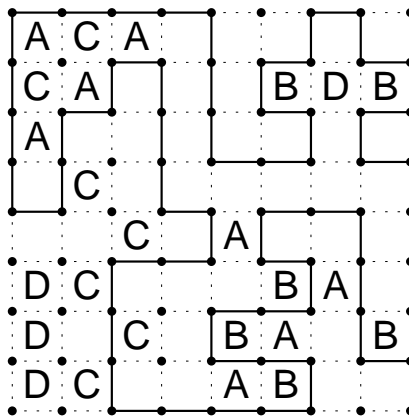

Masyu-Rundweg

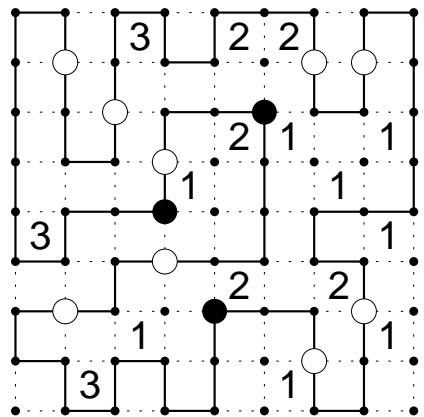

Dreieckig

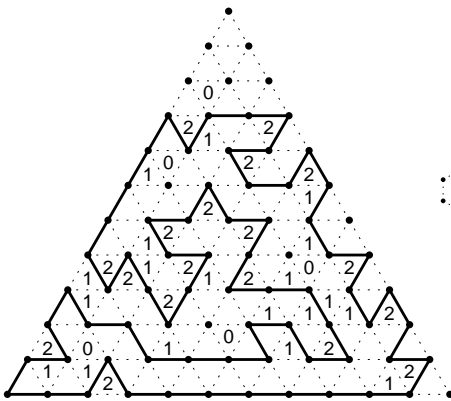

Hexagonal

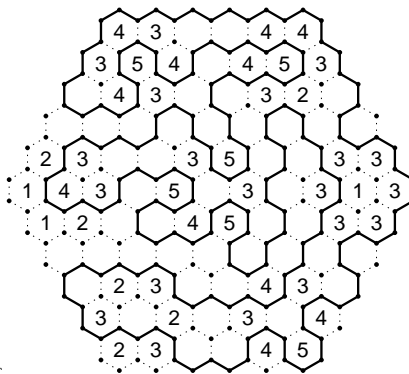

Lügner-diagonal

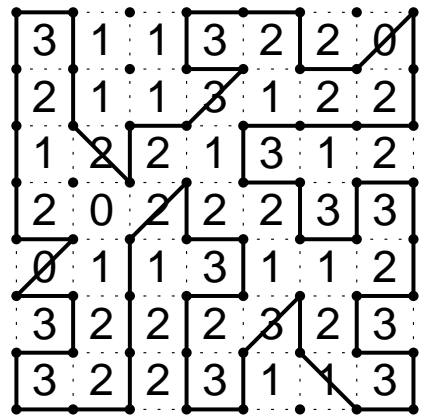

Summenbild

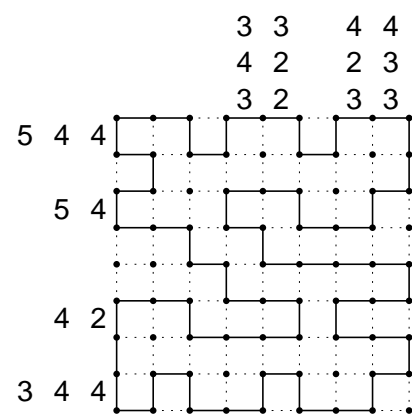

Außen-knapp-daneben

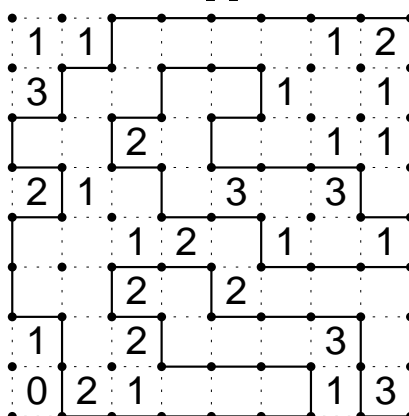

Toroidaler Rundweg

