

Lösungen zu Runde 1: Sprint I – Begrüßungsrätsel

Autor: Bernhard Seckinger

1 Sudoku

O	T	A	G	H
H	G	O	A	T
G	O	T	H	A
A	H	G	T	O
T	A	H	O	G

4 Labyrinth

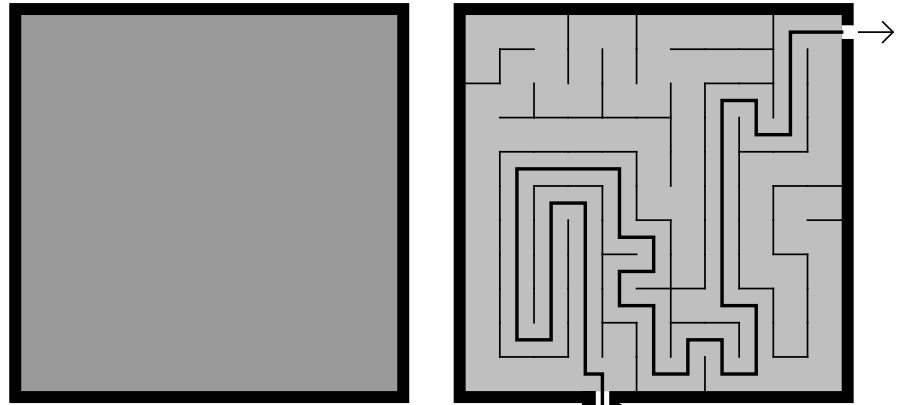

3 Hexagon-Rundweg

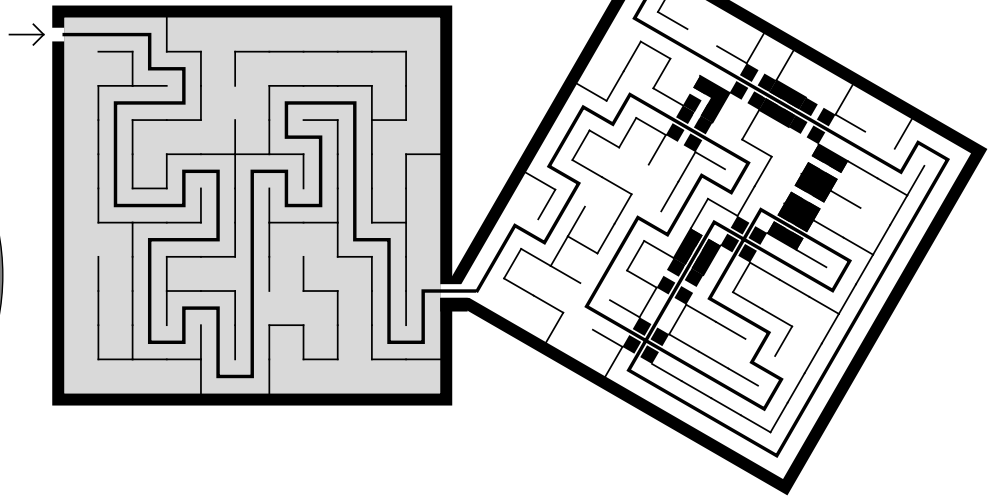
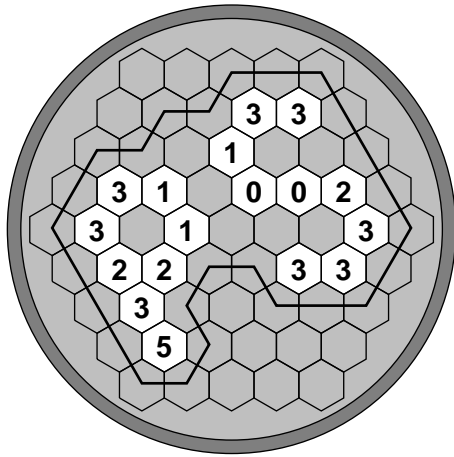

2 Von 1 bis 10

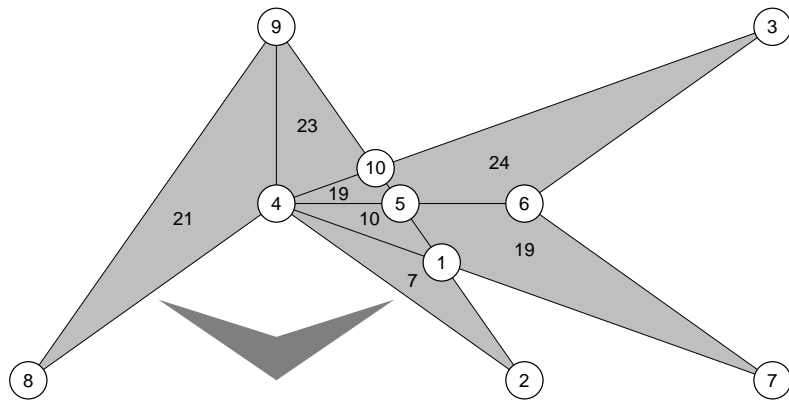

6 Rundweg mit Fehlern

3		3	1		3		3
	3	0	3		0		3
2			2	2	1	0	3
3		1	2	2	1	1	
1	3	3		3	2	3	2
3	2	3	2	2		2	1
3	1		1	3	3	3	3
	3		1	2	3	3	2
1	3		0	2	1		2

5 Domino

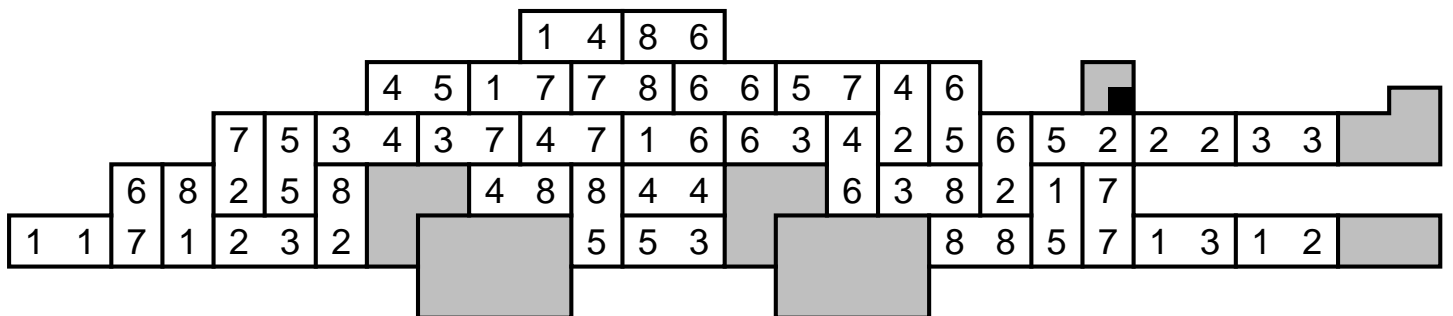

Lösungen zu Runde 2: Bonus – Überlappung

Autor: Bernhard Seckinger

2

7 11 24 17 5 1

17 21 25 2 9 8 6 9 19 24

16 2 4 4 5 19 12 10 17 21

13	17	14	7	6		8	9		3	2	4	5	Japanische																
19	1	13		5	2	4	8		1		7	6	Summen																
6	8	24	6		3	5		4	2	1	8	9																	
	35	3	8	9	6	7	4	1				3																	
12	2	17	1	3	4	5		2		8	9	1																	
10	15	2		1	9		3	8	4		2		Sudoku																
7	2	13		7		2				4	1	8	2	3	4	7	6	5											
2	14	13	2				5	9		6	3	4	5	7	1	2	8	6											
9	3	7	7	9			3		7			5	2	7	6	8	1	3	4										
12	3	13	5	2	4	1		3			6	7	8	5	2	3	4	1											
			3		2	4	1	Ziffernsalat					8	6	4	1	7	5	2	3									
	1		1	3	2	4							4	3	1	2	5	6	7	8	Kropki								
			4	3		1	2											7	1	6	4	3	8	5	2	7	1	6	4
2	3	3	3	1	2	4	3							2	5	3	8	6	4	1	7	2	5	8	3				
2	1	2	2	4	2	4	3	2						7	5	4	3	1	6	2	8								
3	3	4	4	4	7	4						8	2	7	6	5	4	3	1										
3	2	2	7	7	7	4						3	6	2	4	5	1	3	2	5	8	7	4	6					
1	3	3	4	3	7	7						5	1	3	4	5	6	2	7	3	4	6	8	1	5				
3	1	3	4	3	3	7	1	2	6	5	1	3	6	2	4	6	8	1	3	2	5	7							
3	3	4	4	2	2	1	3	5	4	6	2	1	3	4	5	1	6	8	4	3	7	2							
Fillomino							5	3	6	1	7	4	5	6	2	1	3	2											
							4	5	7	6	1	2	4	5	1	3	6												
							6	2	5	4	3	7						4	Hochhaus										
							7	6	4	3	2	1																	
							1	4	2	7	5	3	Domino																

Lösungen zu Runde 3: Labyrinth

Autor: Immanuel Halupczok

1 Escherlabyrinth I

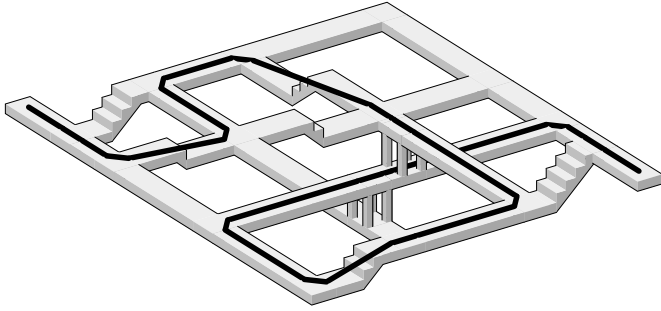

2 Escherlabyrinth II

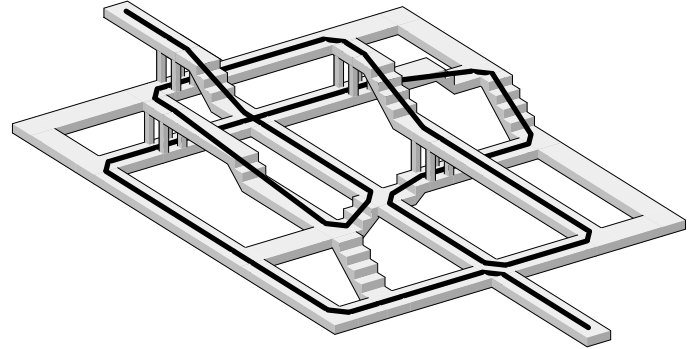

3 Jedes Feld genau einmal

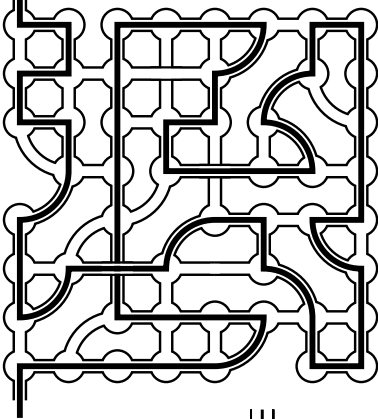

5 Doppellabyrinth I

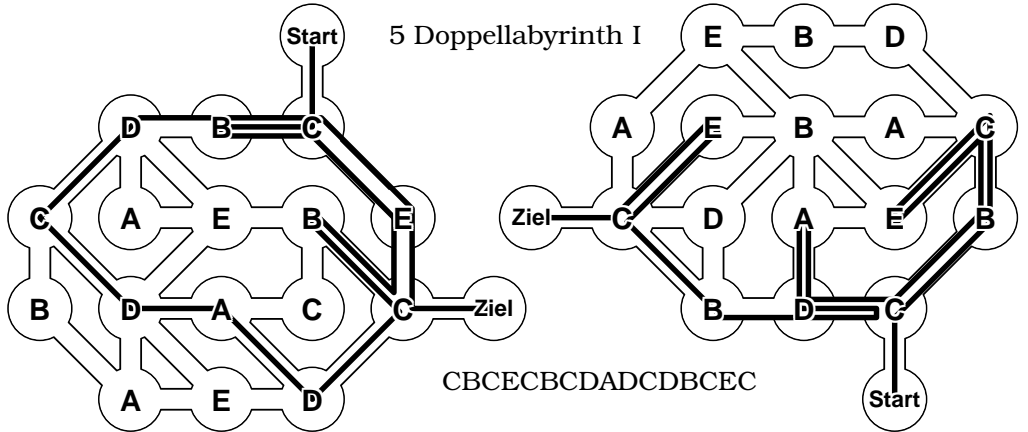

6 Doppellabyrinth II

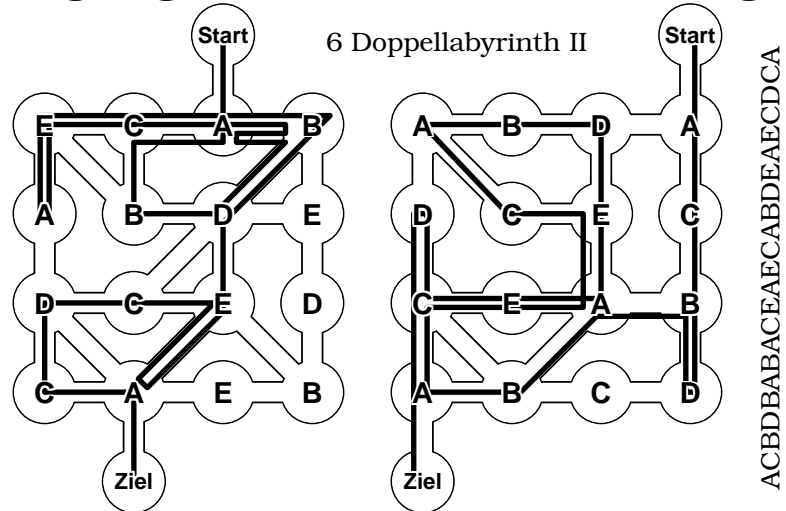

4 Zahlenlabyrinth

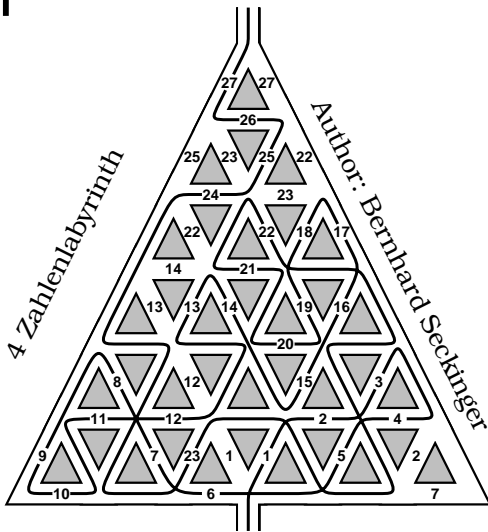

7 Zwei Wege I

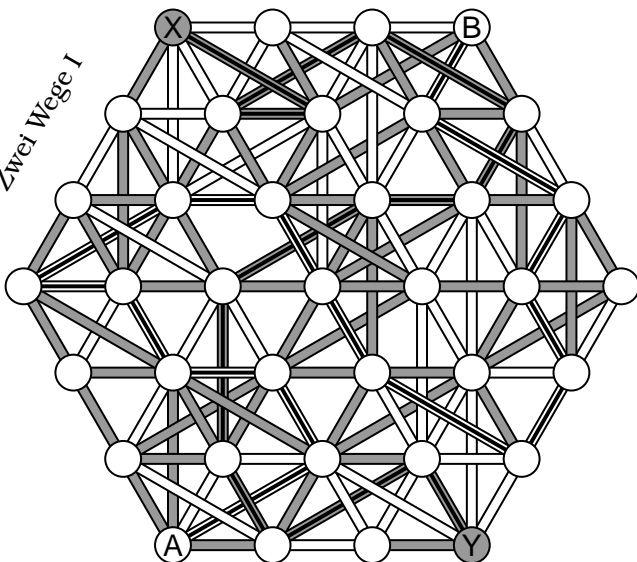

8 Zwei Wege II

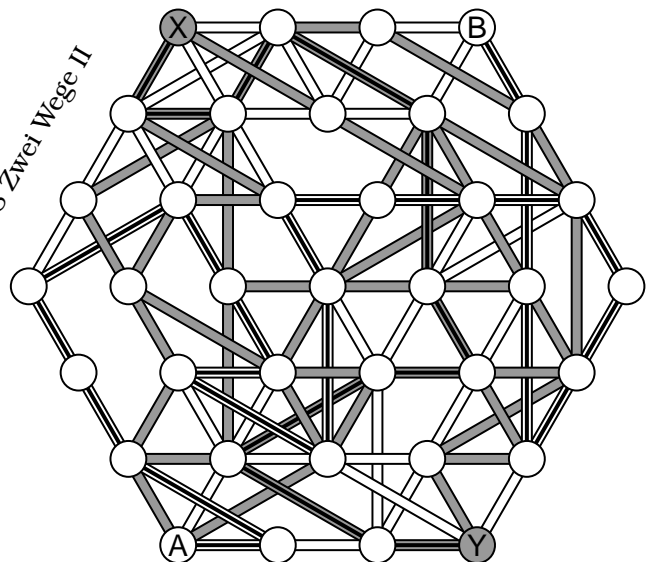

Lösungen zu Runde 4: Gemischte Rätsel

Autor: Bernhard Seckinger

1 P-Pentomino-Zerlegung

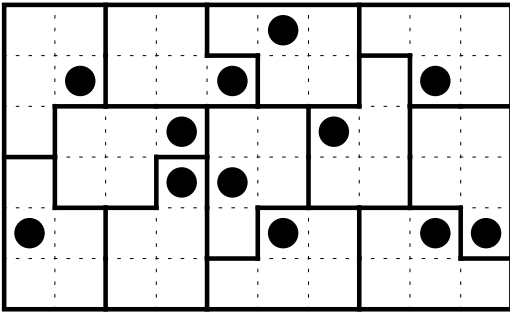

2 Buchstabensalat

	A			B	C	C
B		B	A	C		C
	C			A	B	
	B	A	C			C
		C	B		A	
B						

4 Schlangenwörter

	E	I	M	E	R
	A	B	U	D	W
S	B	L	T	A	N
T	O	U	R	L	E
	R	K	U	M	M
S	C	H	W	I	A

Autorin: Silke Berendes

3 Hexagonal Kropki

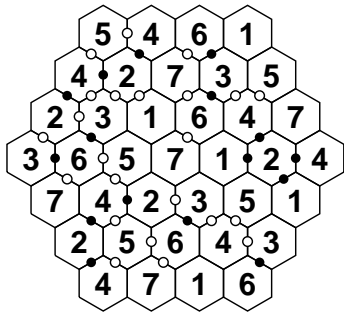

5 Gedreht

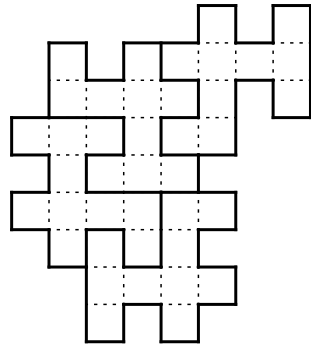

6 Gebietssummen

2	4	3	5	6	1	7
5	1	4	7	2	3	6
3	6	7	2	4	5	1
4	2	1	6	3	7	5
6	7	5	4	1	2	3
1	5	6	3	7	4	2
7	3	2	1	5	6	4

7 Von 1 bis 36

→	↓	↓	←	↓	↓
22	9	3	2	23	14
↑	→	→	↓	←	↑
21	31	12	33	32	13
↓	↑	↓	←	←	←
28	8	35	34	7	27
↑	→	↑	↑	→	↑
20	10	11	1	25	26
→	↑	→	↓	↑	←
29	30	36	16	24	15
↑	→	←	→	↑	←
19	5	4	17	6	18

8 Laser

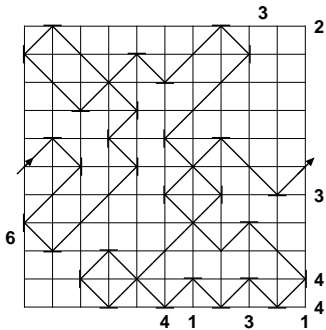

9 Doppelstern

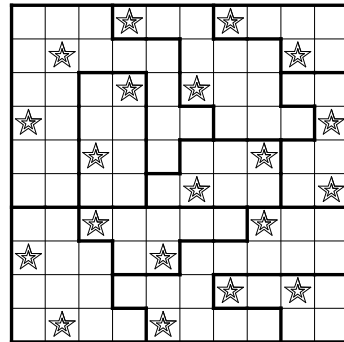

11 Radar

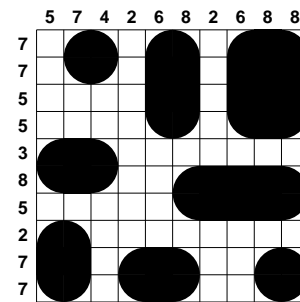

13 Rundweg

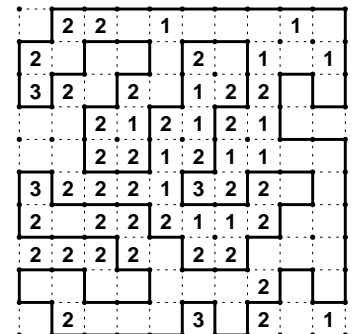

12 Dominoschlange

3	5	7	5	1	6	3	3	4	7	1	1	5	5	5	5
3	3	4	4	6	6	6	1	4	3	3	1	5	3	3	4
6	2	4	1	5	5	7	6	6	6	3	4	6	6	6	6
①	4	4	1	4	2	7	3	2	5	3	7	7	1	3	①
1	1	7	2	4	4	1	3	5	1	7	7	4	4	3	4
4	3	3	2	2	4	1	3	5	1	1	7	5	5	5	1
1	3	7	7	2	4	4	4	4	2	2	2	7	7	7	1
5	4	4	7	2	1	3	1	1	6	1	2	6	7	2	1
2	2	6	7	7	1	6	3	1	4	1	3	6	6	2	2
6	2	6	4	5	5	7	2	2	2	2	4	3	5	2	6
6	4	6	4	6	7	7	5	7	3	4	1	3	1	1	1
6	4	5	1	6	5	5	5	4	4	4	3	3	4	5	5

Autorin: Silke Berendes

10 Urnenrätsel

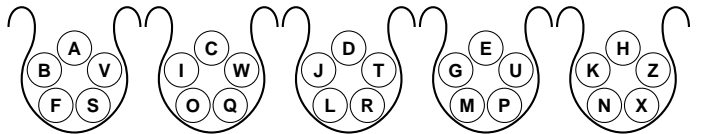

Autor: Arvid Baars

14 Pentomino

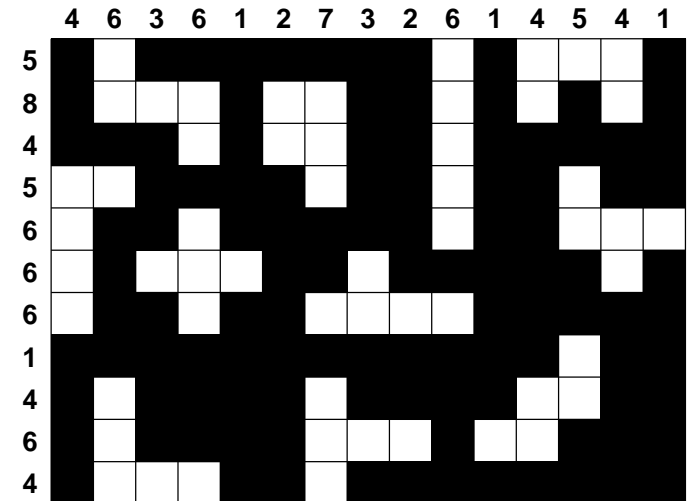

Autorin: Silke Berendes

Lösungen zu Runde 5: Streng geheim

Autor: Bernhard Seckinger

1 U-Bahn

				+	0	0	1	0	1	0
				-	0	3	0	2	1	2
				-	1	1	2	1	3	2
				-	4	2	2	2	1	2
+	+	+	+							
0	0	1	4							
0	4	2	0							
0	1	2	2							
2	2	0	1							
0	1	3	2							
0	0	2	4							

4 Pfeile

		↘	↓	↓	↗	↓		
↘	0	4	3	1	1	↗		
→	4	5	7	2	5	←		
→	3	7	4	6	3	←		
→	3	4	8	2	5	←		
↗	0	4	2	2	2	↘		
	↗	↑	↑	↗	↖			

2 Kakuro

		8	11	18			34	5	8
6	2	3	1			9	6	1	2
23	6	8	9			17	7	4	6
			25	8	7	1	9		
11	7	4		20	9	3	8	11	17
44	9	5	7	6	2	4	3	8	
			24	9	8	7	17	8	9

3 Schlange

		3	7	6	7	5	9	4	1	8	4	3	3			
3					7	6	5									
3				9	8		4									
4				10			3					59	60			
6		12	11			1	2					57	58			
2		13										56				
5		14			18	19	20					55				
6		15	16	17			21	22				54				
2								23				53				
7		32	31	30	29			25	24			52				
8		33			28	27	26					51	50	49	48	
3		34	35													47
11			36	37	38	39	40	41	42	43	44	45	46			

5 Magnetplatten

+		3	2	2	2	3	4	1	5	2	2
	-	3	4	1	2	3	3	4	2	2	2
4	3	+			-	+		-	+		
3	4	-					+		-	+	-
4	3			-	+			-	+		+
0	1							-			
3	2	+	-					+	-	+	
1	5	-				-	+		-		-
5	2	+	-	+				+		-	+
3	0			+				+			+
1	3			-		+		-			-
2	3	-	+					-			-

Lösungen zu Runde 6: Sprint II – Wörter mit N und T

Autor: Bernhard Seckinger

1 Wörter mit N und T

UNUMS	TRI	T	TE	NE	REN		KAN	TO	NS	N	AT	ION
TO	ST			BENA	N	N	T	EN		ETZDI		ISATIO
ESSLICHEN		AN	TU	N		ICHT		TE	STR	EN	NE	N
	AT	TE	ST		HIN	EINSC	HAUT		AHLT	ST		SNI
AT	TACKE	N		IN	NE	HALT	EN	DEN			MAN	TRA
MUNGSORGA		NE	UN	T		EN	GEN		FERN	SEKUN	DAN	T
NE	UN		GNAD	EN	AKT			TRICK	STU	DEN	T	
	MILITAER	KONV	EN	T	IONE	N		SEN	DEN		IN	NE
ZEIT		EKT		IONE	N	AN	TRIEB		T	ITA	N	
WORT	UN	ION	ISTE	N		N	EN	N	EN		EN	TE
	BET	EN			KET	TE		ICHTEI		NA		N
THR	ON		NI	TRA	T		SON	N	ENFI	N	STER	NIS
	T	IN	T	EN	EN	TWURF		TRE		N		TUR
KONZ	EN	T	RAT		RING		UN	T	ERSTUE	T	ZUNGSLI	NIE
ERT		AKT	EN	ORDNER		EIN	RAST	EN		ET		REN

Lösungen zum Stechen

Autor: Bernhard Seckinger

1 Rundweg

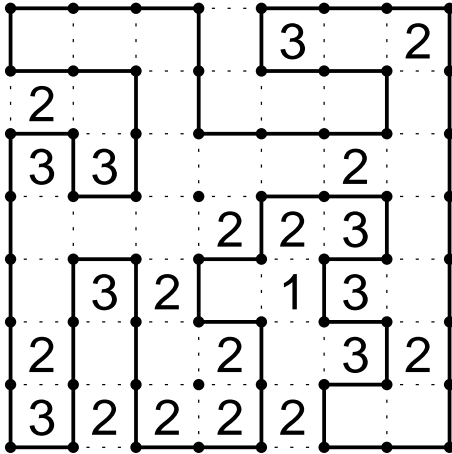

2 Hochhaus

	2	3	4		
3	3	4	1	5	2
2	2	5	4	3	1
	1	2	5	4	3
	5	1	3	2	4
	4	3	2	1	5
		3	4		